













510x510 HERKULES X-CNC

 mm	 mm	 a b a x b	 a b a x b
510	510	510x530	500x450

	 kW	 m/min	 mm	 kg
3x400 V	7,5	15-80	6060x54x1,6	
Lmin	Lmax	B	Hmax	Hmax
3360	3720	2400	2070	2360
				810

* doporučená hodnota. Při překročení doporučeného maximálního průměru není možné garantovat výkon pilového pásu!
/recommended value. The blade performance cannot be guaranteed when the recommended diameter is exceeded!

 a x b - řezání svazků bez horního přitlaku / cutting of the bundle without top clamping/

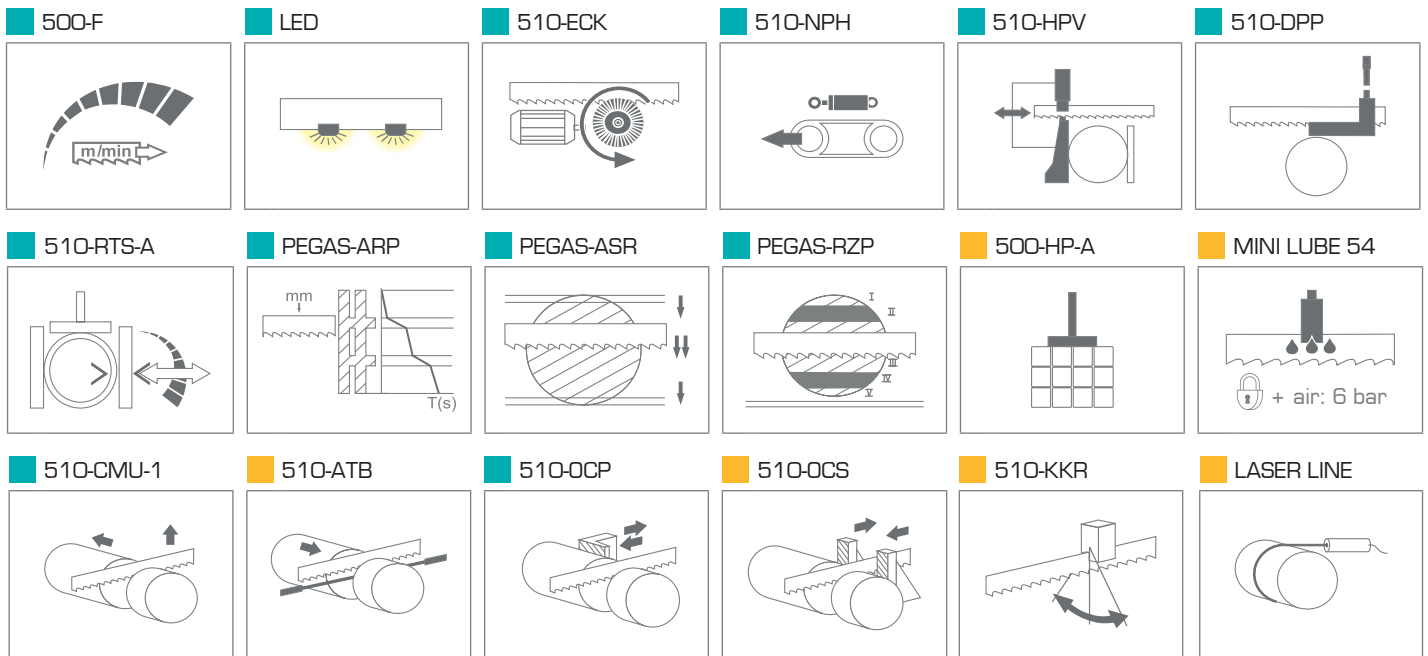

500-RDP 1000/620
+RBR

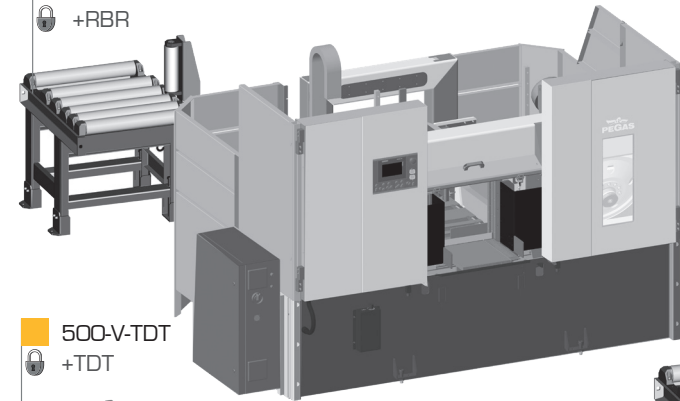

510-VTT

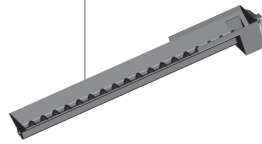

BLUEBOX

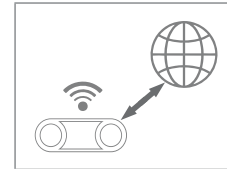

PCP

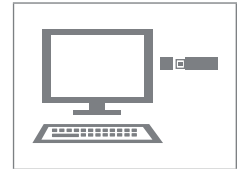

BOX-TRI

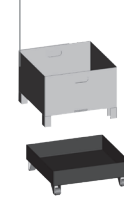

BOX-TAH

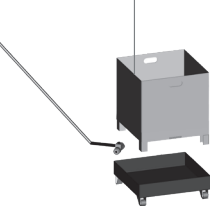

BOX-PCS

500-RDZ 1000/620
+RBR



500-RBRS
+RBR

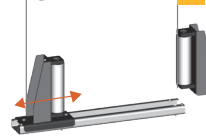

500-RBR

500-V-TDT
+TDT



500-TDT-RBRS
+TDT-RBR

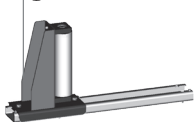

500-TDT-RBR



VZM-620



500-VN
+RDT



500-V
+RDT



500-RDH



510-TDT 1000/570



510-TDT 2000/570



500-RDT 2000/620



500-RDT 1000/620

510x510 HERKULES X-CNC

■ STANDARD ■ OPTION



PEGAS-GONDA s.r.o., Čs.armády 322, 684 01 Slavkov u Brna, CZECH REPUBLIC
Tel: 00420-544 221 125 (126), Fax: 00420-544 227 389, E-mail: pegas@gonda.cz
www.pegas-gonda.cz

- výrobce si vyhrazuje právo provádět změny technických údajů, technické údaje odpovídají 1.3.2018
/ producer has the right to make changes of technical data, technical data are valid on 1.3.2018 /
- pila na fotografii není vždy v základním provedení, uvedené rozměry odpovídají stroji v základním provedení
/ the machine in the picture is not always in the basic version, mentioned diameters are for machine in basic version /

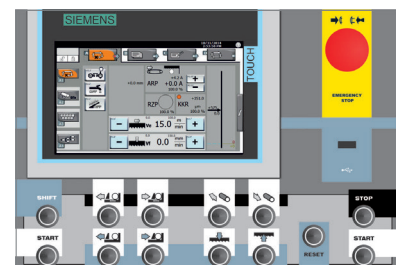

CONTROL PANEL:SIEMENS (X-CNC)