













400x400 HERKULES X-CNC

 mm	 mm	 a b a x b	 a b a x b
400	400	400x400	400x250

			 mm		
3x400 V	4,0	20-100	5580x41x1,3		3560
Lmin	Lmax	Bmin	Bmax	H	V
2900	3260	1810	2330	2210	800

* doporučená hodnota. Při překročení doporučeného maximálního průměru není možné garantovat výkon pilového pásu!
/recommended value. The blade performance cannot be guaranteed when the recommended diameter is exceeded!

 a x b - řezání svazků bez horního přitlaku / cutting of the bundle without top clamping/

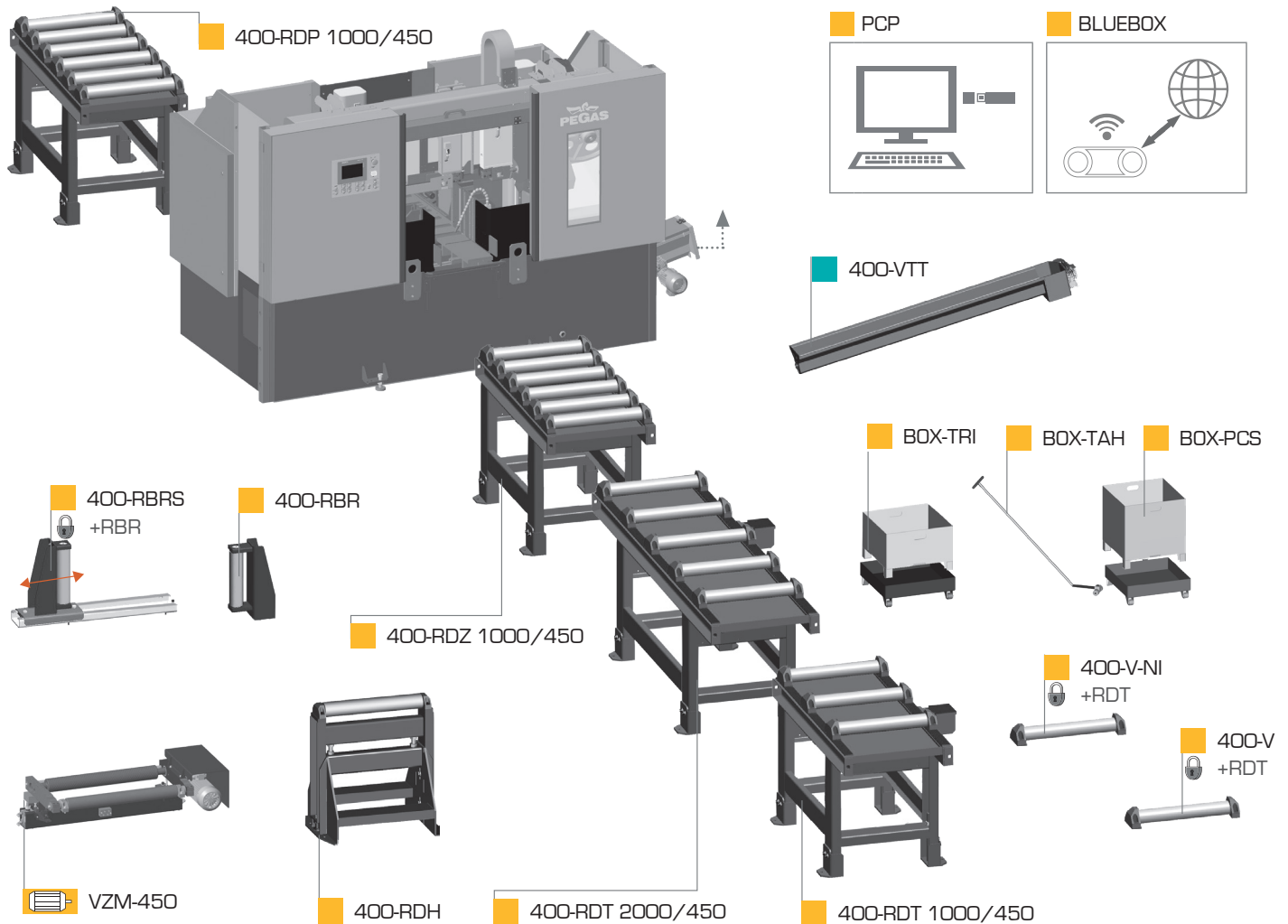
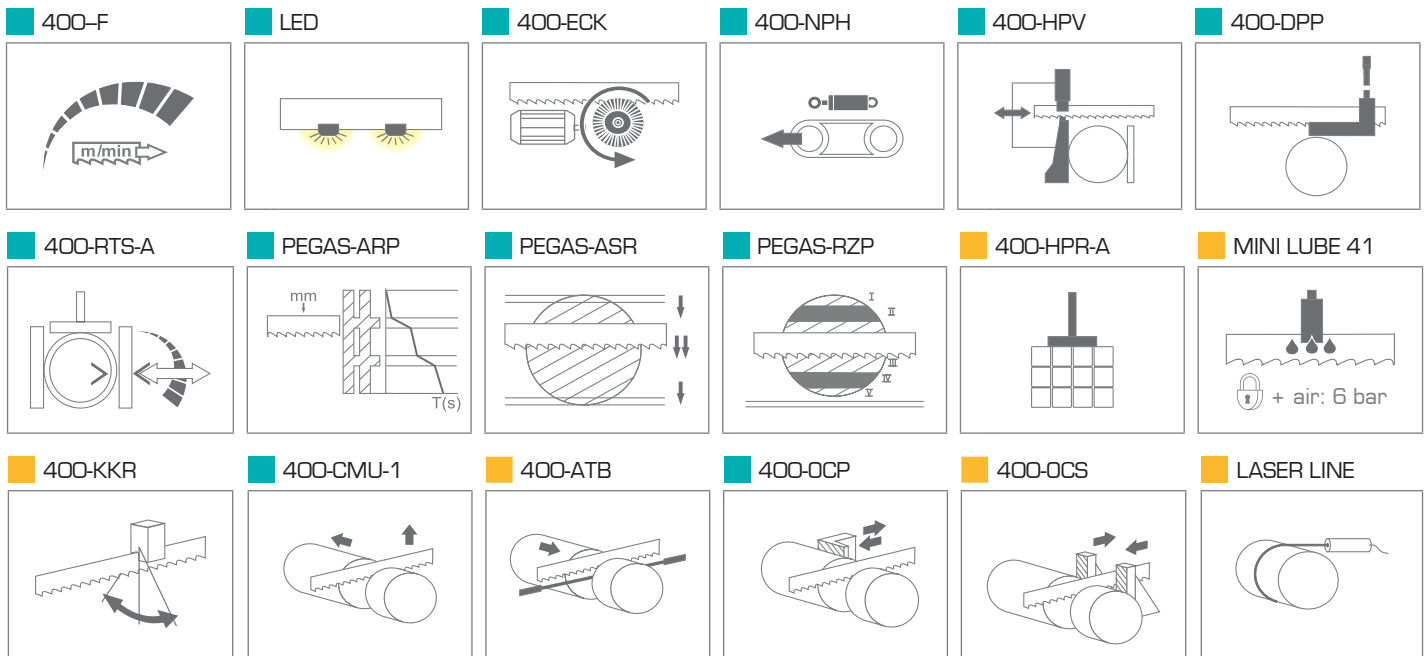

400x400 HERKULES X-CNC

■ STANDARD ■ OPTION



PEGAS-GONDA s.r.o., Čs.armády 322, 684 01 Slavkov u Brna, CZECH REPUBLIC
Tel: 00420-544 221 125 (126), Fax: 00420-544 227 389, E-mail: pegas@gonda.cz
www.pegas-gonda.cz

- výrobce si vyhrazuje právo provádět změny technických údajů, technické údaje odpovídají 1.3.2018
/ producer has the right to make changes of technical data, technical data are valid on 1.3.2018 /
- pila na fotografii není vždy v základním provedení, uvedené rozměry odpovídají stroji v základním provedení
/ the machine in the picture is not always in the basic version, mentioned diameters are for machine in basic version /

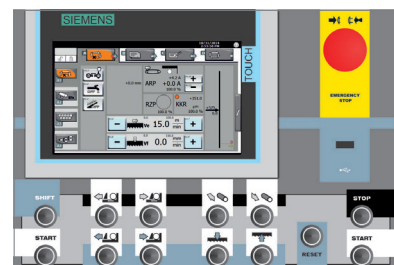

CONTROL PANEL:SIEMENS (X-CNC)