











300x320 GH-LR (II. generace/generation)

	$\square 0^\circ$	$\nabla 45^\circ$	$\square 60^\circ$	$\triangle 45^\circ$	$\triangle 60^\circ$	$\begin{matrix} a \\ \square \\ b \\ a \times b \end{matrix}$
	300	300	200	270	x	x
	180*	110*	80*	110*	x	x
	320x300	290x300	190x190	270x200	x	320x160

					
3x400V	1,3/1,8	35/70	3660x27x0,9		645
L	B	Hmin	Hmax	V	
2050	1170	1420	2180	800	

* doporučená hodnota. Při překročení doporučeného maximálního průměru není možné garantovat výkon pilového pásu!
/recommended value. The blade performance cannot be guaranteed when the recommended diameter is exceeded!

 $a \times b$ - řezání svazků bez horního přitlaku / cutting of the bundle without top clamping/

300-M2V

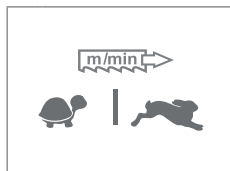

LIGHT L1

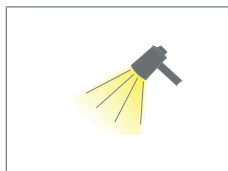

300-PCK

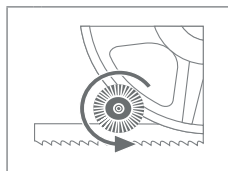

290-RP

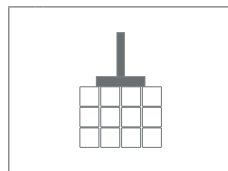

MINI LUBE 27-34

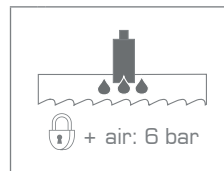

R 390

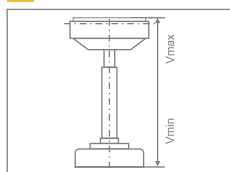

	S (mm)	Vmin (mm)	Vmax (mm)
R	390	760	980

OZD 1000
OZD 2000
OZD 3000
OZD 4000
OZD 5000
OZD 6000

OZ 1000
OZ 2000
OZ 3000
OZ 4000
OZ 5000
OZ 6000

OZ 0000

RB 200

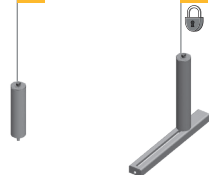

RBS 200/390
+RB



RHS 390
+RBS+RB

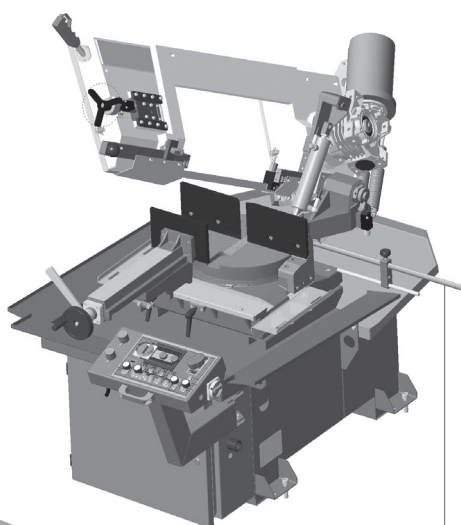

300-SRZ-R

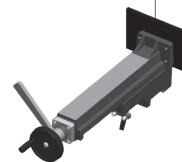

RD VR-390

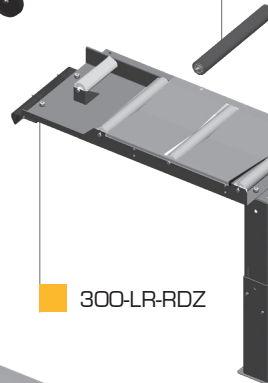

300-LR-RDP

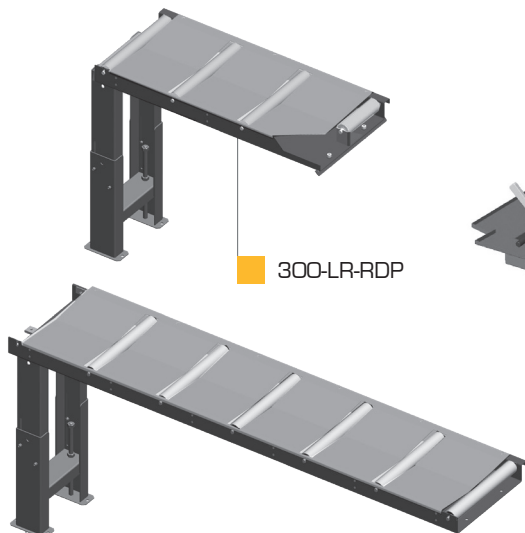

OZM

300-LR-RDZ

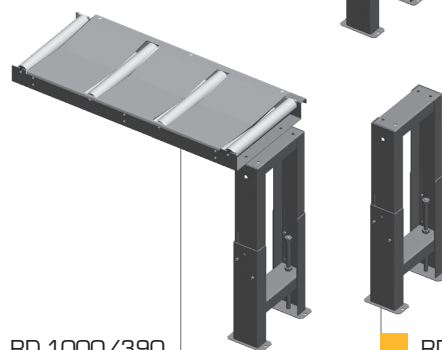

RD 2000/390

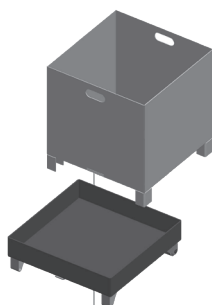

BOX-PCS

BOX-PCS

BOX-TAH



BOX-TRI

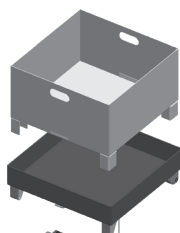

RD 1000/390



RDN



300x320 GH-LR (II. generace/generation)

STANDARD

OPTION



PEGAS-GONDA s.r.o., Čs.armády 322, 684 01 Slavkov u Brna, CZECH REPUBLIC
Tel: 00420-544 221 125 (126), Fax: 00420-544 227 389, E-mail: pegas@gonda.cz
www.pegas-gonda.cz

- výrobce si vyhrazuje právo provádět změny technických údajů, technické údaje odpovídají 1.3.2018
/ producer has the right to make changes of technical data, technical data are valid on 1.3.2018 /
- pila na fotografii není vždy v základním provedení, uvedené rozměry odpovídají stroji v základním provedení
/ the machine in the picture is not always in the basic version, mentioned diameters are for machine in basic version /

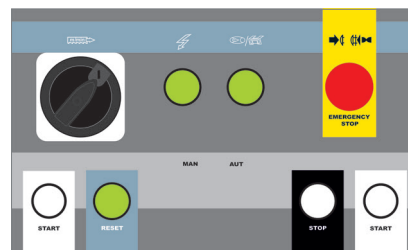

CONTROL PANEL:GH